

GRReddy®

***GR*Reddy Turbo Kit**

Nissan 300ZX TT CZ32 (VG30DETT) Twin TD05-16G



Nissan 300ZX TT CZ32 (VG30DETT)

Installation Manual

Please read the entire manual before installing this kit.

Application:

Make	Model	Chassis	Year
Nissan	300ZX	CZ32	90-96

- This **GRReddy TD05 16G Twin Turbo Kit** is designed only for the vehicles specified above
- This **GRReddy TD05 16G Twin Turbo Kit** is a complete bolt on replacement and once installed it is ready for use. For optimum performance it is highly recommend to also install the **GRReddy 300ZX Blow-off Valve Kit**, and especially the **GRReddy Intercooler Kit** for 300ZX.
- This **GRReddy TD05 16G Twin Turbo Kit** is legal in California only for racing vehicles which may never be used upon a highway.

○ パ ー ツ リ ス ト

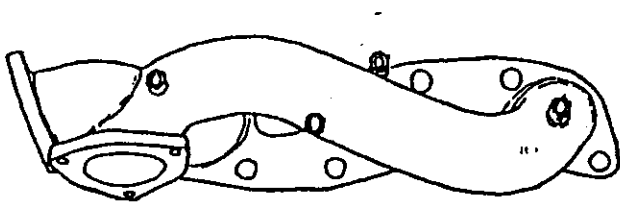

1

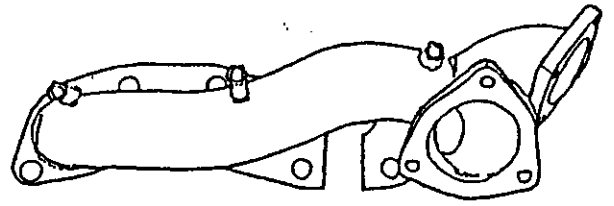

2



3

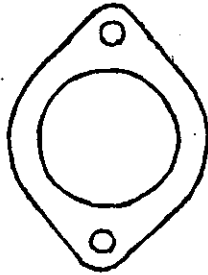

4

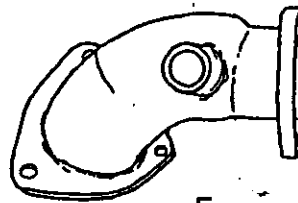

5
RIGHT

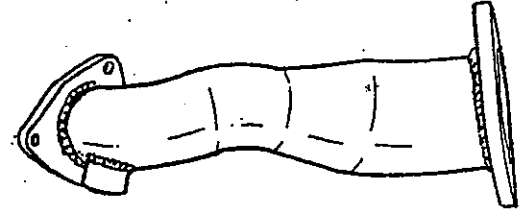

6
LEFT.
(DRIVER SIDE)

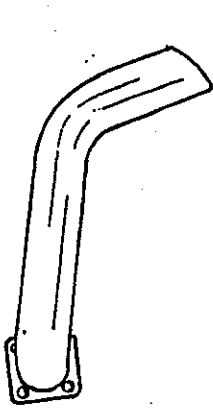

7
RIGHT

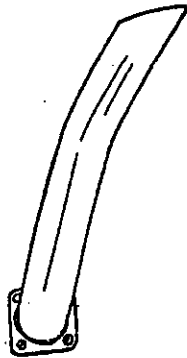

8
LEFT.

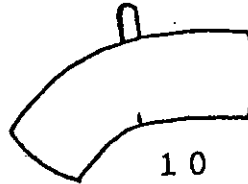

10



9



11

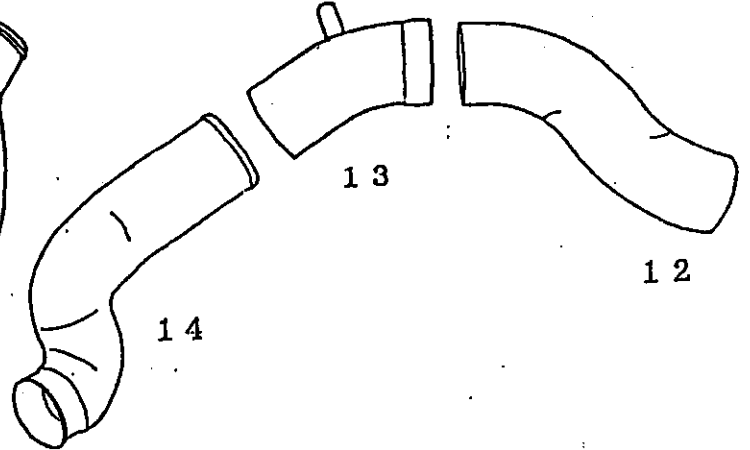

12

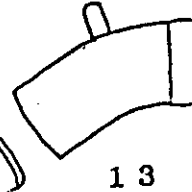

13

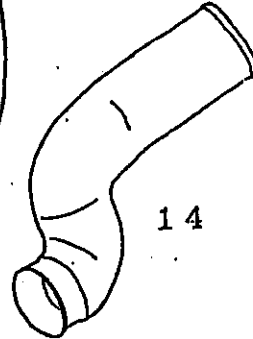

14

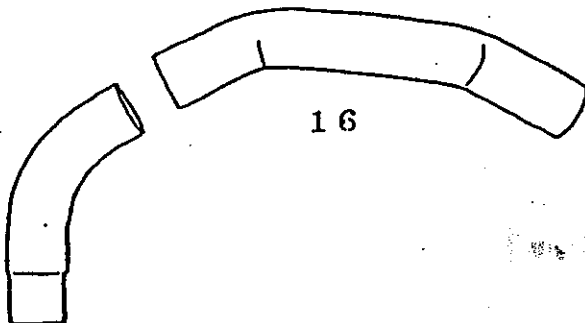

15

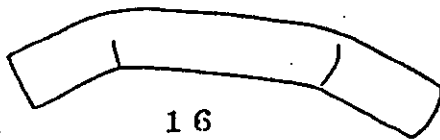

16

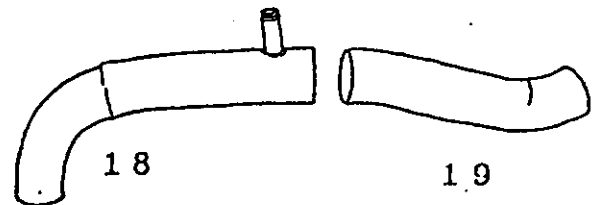

18

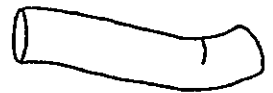

19

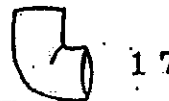

17

○パーツリスト

1/8 PT. MALL/FEMALE

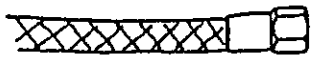

20

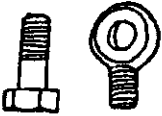

21



22



23



24



25

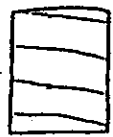

31

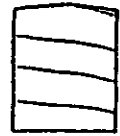

32

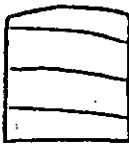

33



26

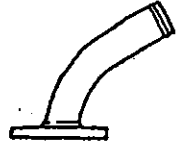

27



28

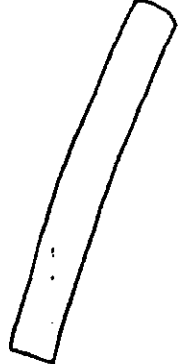

29



30

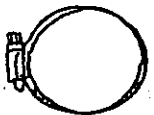

34

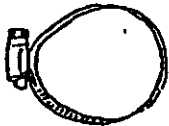

35

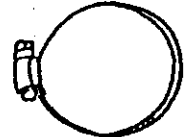

36



37

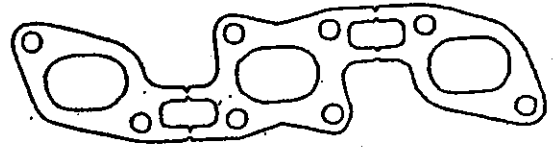

38

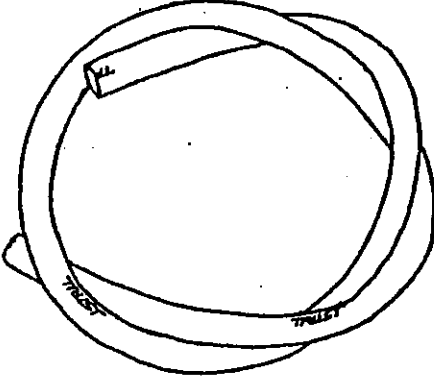

42

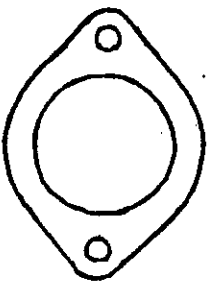

56

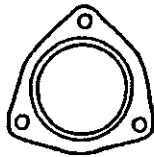

39

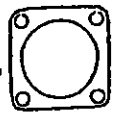

40

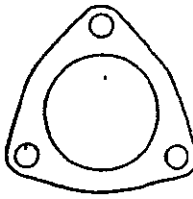

41



46



47



48



43

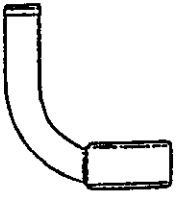

44



45

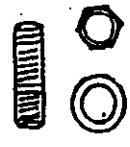

49

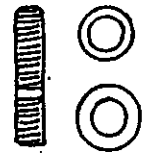

50



51



52



53



54

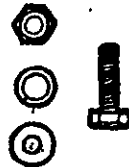

55

○ パ ー ツ リ ス ト

1.	EXマニホールド	R	45φ-42φ	1
2.	"	L	45φ-42φ	1
3.	W/Gアダプター	R	42φ	1
4.	70φ楕円フランジ	L	(マフラー加工用)	1
5.	マフラーアダプター	R	50φ-60φ	1
6.	"	L	50φ-70φ (専用)	1
7.	W/G開放チューブ	R	38φ (専用)	1
8.	"	L	38φ (専用)	1
9.	エアークチューブ	I-1R	(60φスチール)	1
10.	"	I-2R	(60φスチール) 12φチューブ付	1
11.	"	I-3R	(純正部品加工)	1
12.	"	I-1L	(60φスチール)	1
13.	"	I-2L	(60φスチール) 12φチューブ付	1
14.	"	I-3L	(純正部品加工)	1
15.	コンプレッションチューブ	C-1R	(45φ-50φスチール)	1
16.	"	C-2R	(50φスチール)	1
17.	"	C-1L	(45φ 5R 90° アルミエルボー)	1
18.	"	C-2L	(45φ-50φスチール)	1
19.	"	C-3L	(50φスチール)	1
20.	オイルプレッシャーホース	STD	600mm	2
21.	"	パンジョーユニオン	10φ オス・メス (タービン)	2
22.	"	銅パッキン		4
23.	"	90φユニオン	1/8PF オス・メス	1
24.	"	ストレートユニオン	1/8PF オス-1/8PT オス	1
25.	"	ストレートユニオン	(L型HR-30専用)	1
26.	オイルリターンチューブ	19φ R		1
27.	"	L	(専用)	1
28.	オイルリターンガスケット	(TD-05用)		2
29.	オイルリターンホース	19φ×200mm		2
30.	ホースバンド	19φ	トライドン 12#	4

31.	シリコンホース	45φ×70mm							3	
32.	"	50φ×70mm							6	
33.	"	60φ×70mm							4	
34.	ホースバンド	45φ	トライドン28#	(コンプレッションチューブ)					6	
35.	"	50φ	"	32#	(")		12	
36.	"	60φ	"	36#	(")		8	
37.	"	15φ	"	6#	(ブローバイホース)				2	
38.	EXマニホールドガスケット	(純正部品)							2	
39.	タービン IN・OUTガスケット	(TD-05用)							4	
40.	W/Gアダプターガスケット	(Rタイプ OUT側)							2	
41.	マフラーアダプターガスケット	(シルビア S-13用)							2	
42.	ゴムホース	8φ×1000mm							1	
43.	ホースバンド	8φ	トライドン4#						12	
44.	オイルクーラーバンジョーユニオン	(オス・メス) 専用パーツ							1	
45.	"		銅パッキン						2	
46.	6φホースメクラユニオン								2	
47.	8φホースメクラユニオン								2	
48.	4φメクラキャップ								2	
49.	10mm×30mm	P=1.25	ステンレス	スタッド	B	S/W	—	N	(EXマニ)	2
50.	10mm×45mm	P=1.25	ステンレス	スタッド	B	S/W	F/W	N	(マフラーアダプター)	6
51.	10mm	P=1.25	ステンレス		—	S/W	—	N	(EXマニ)	10
52.	8mm×30mm	P=1.25	ステンレス	スタッド	B	S/W	—	N	(EXマニタービン)	12
53.	6mm×25mm	P=1.0	ステンレス		B	S/W	—	—	(W/Gアダプター)	8
54.	6mm×15mm	P=1.0	ステンレス		B	S/W	—	—	(オイルリターツ)	4
55.	10mm×35mm	P=1.25	スチール		B	S/W	F/W	N	(マフラーアダプター~マフラー)	2
56.	70φ楕円ガスケット								(マフラーアダプター~ガスケット)	1

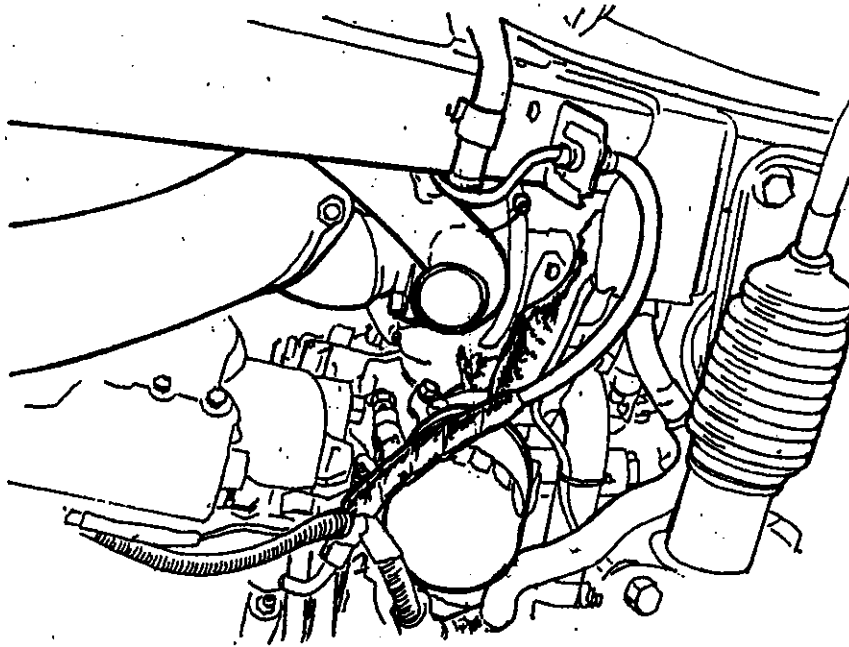

R 部

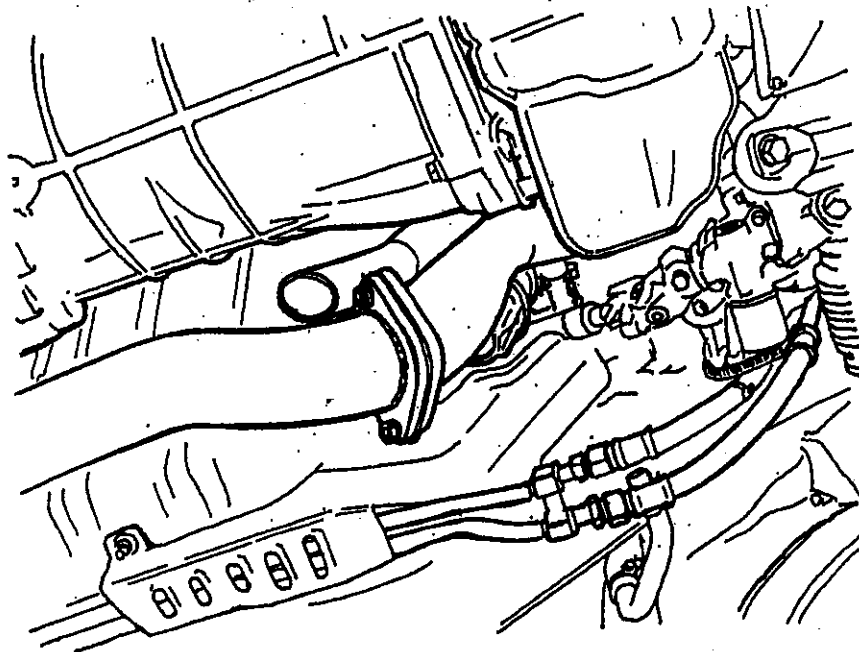

L 部
LEFT (DRIVER SIDE)

2. Removal of Stock Parts

2-1 Preparation

- (1) Place the vehicle onto a automotive lift (see owners manual)
- (2) Disconnect the negative terminal of the battery.
- (3) Drain fluids: coolant, oil, and power steering.

Turbo model

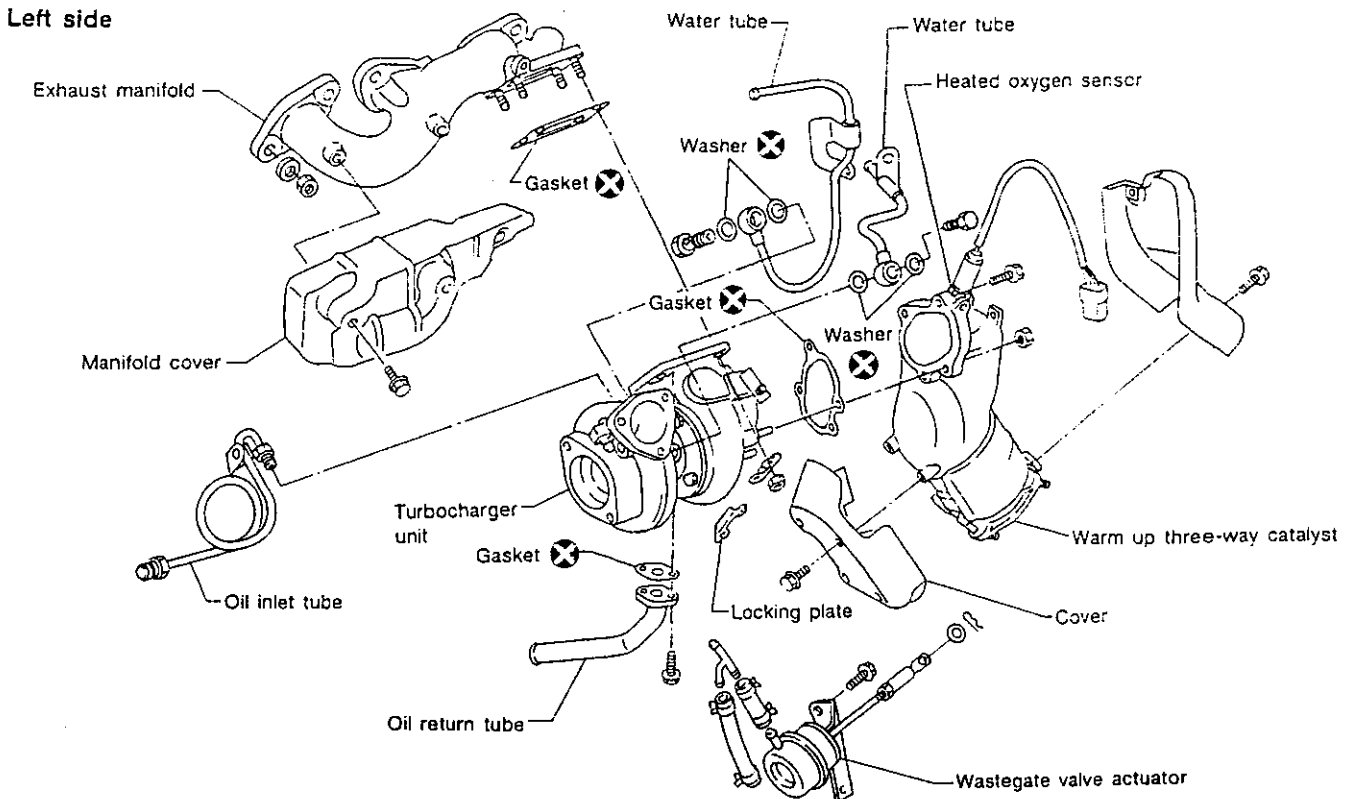
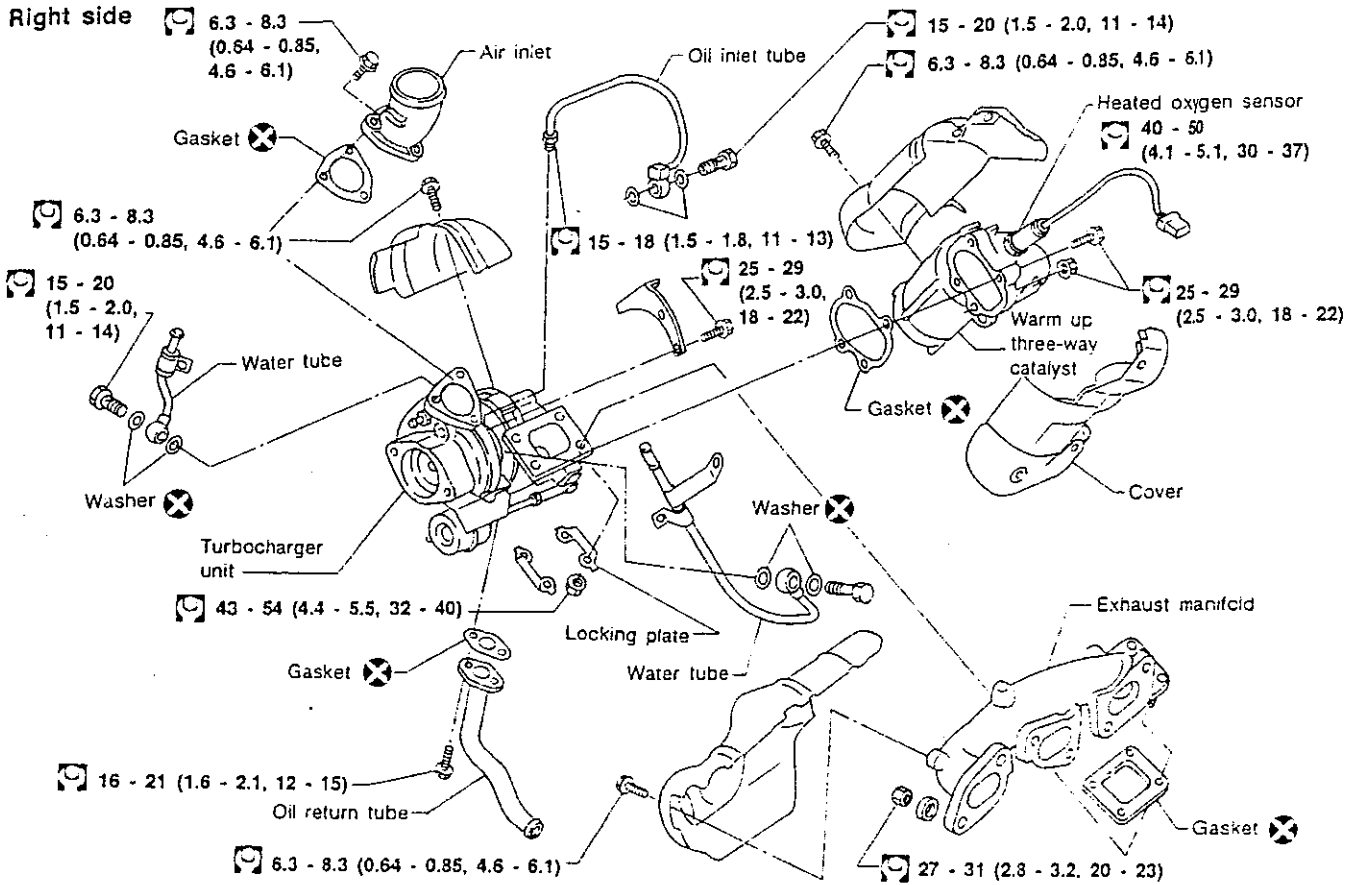

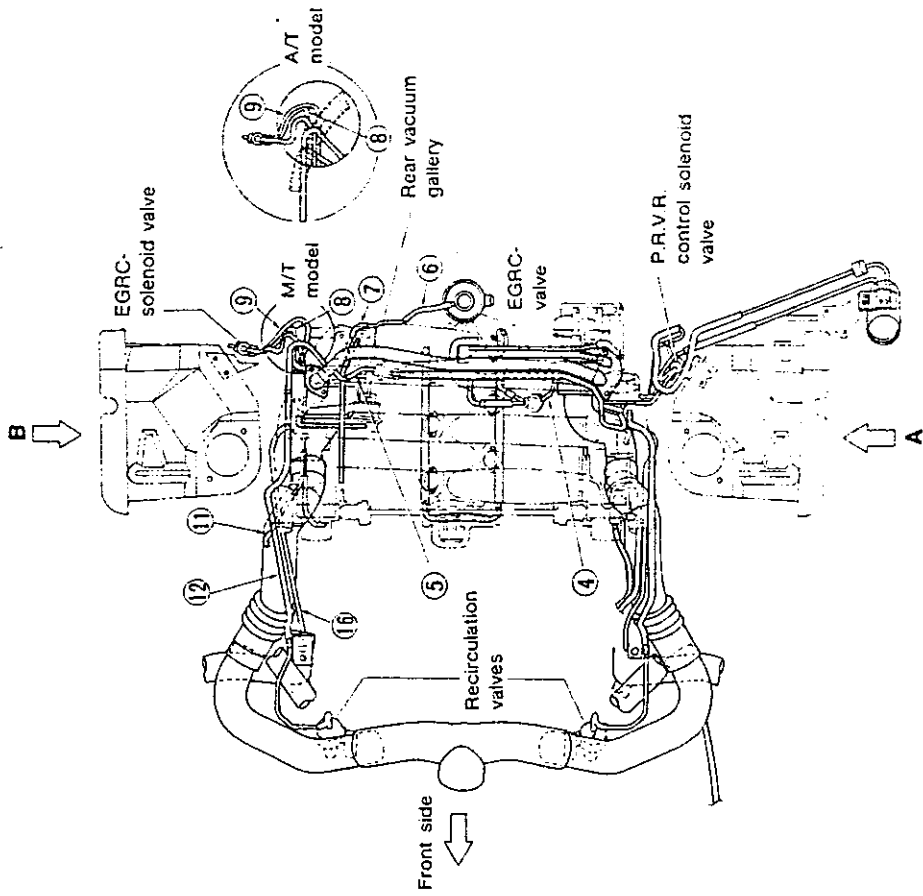
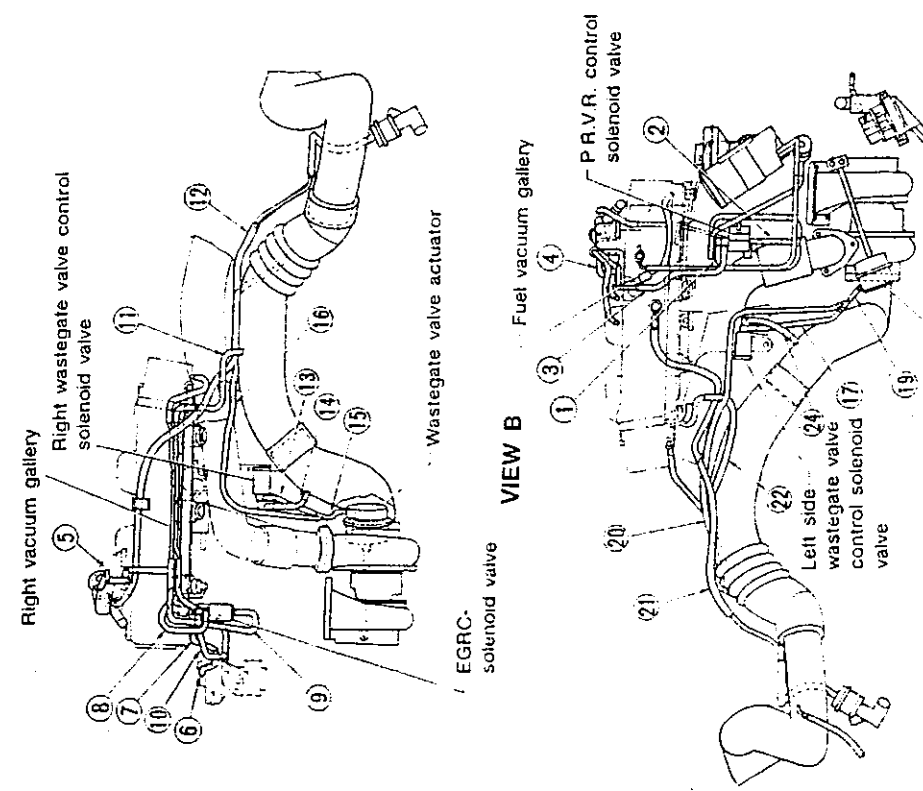

- (1) P.R.V.R. control solenoid valve to Vacuum tank
- (2) P.R.V.R. control solenoid valve to Intake manifold collector
- (3) P.R.V.R. control solenoid valve to Fuel vacuum gallery
- (4) Fuel pressure regulator to Fuel vacuum gallery
- (5) Fuel damper to Balance tube
- (6) EGRC-solenoid valve to Rear side vacuum gallery
- (7) Rear side vacuum gallery to Right side vacuum gallery
- (8) EGRC-solenoid valve to Right side vacuum gallery
- (9) Throttle body to EGRC-solenoid valve
- (10) EGRC-solenoid valve to Right side air gallery through 3-way connector
- (11) Air duct to Right side air gallery
- (12) Right side recirculation valve to Intake manifold collector
- (13) Right side wastegate valve control solenoid valve to Air pipe through 3-way connector
- (14) Right side wastegate valve control solenoid valve to Suction pipe
- (15) Right side wastegate valve actuator to Air pipe through 3 way connector
- (16) Air pipe to 3-way connector (For right side wastegate valve control)
- (17) Left side wastegate valve control solenoid valve to Air pipe through 3-way connector
- (18) Left side wastegate valve control solenoid valve to Suction pipe
- (19) Left side wastegate valve actuator to Air pipe through 3-way connector
- (20) Air pipe to 3-way connector (For left side wastegate valve control)
- (21) Left side recirculation valve to Intake manifold collector
- (22) Canister purge line

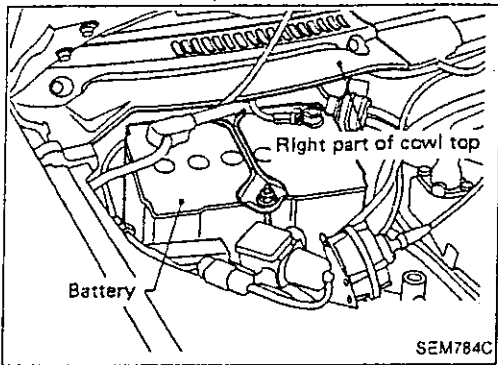

Removal

RIGHT SIDE UNIT

1. Remove right part of cowl top.
2. Remove battery.

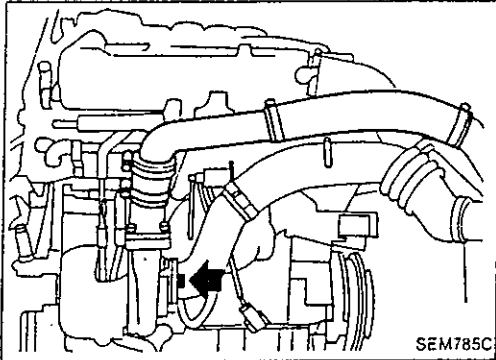

3. Remove air inlet hose and pipe.
4. Disconnect lower pipe from turbocharger unit.

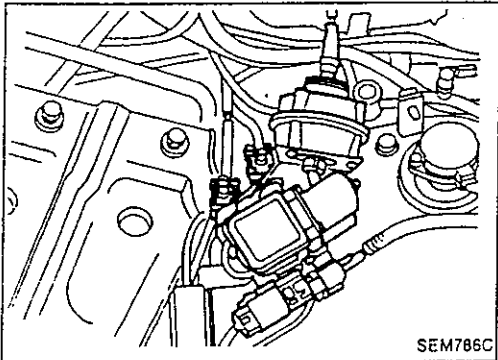

5. Remove A.S.C.D. bracket with wiper motor and solenoid valves.
6. Disconnect heated oxygen sensor harness connector.

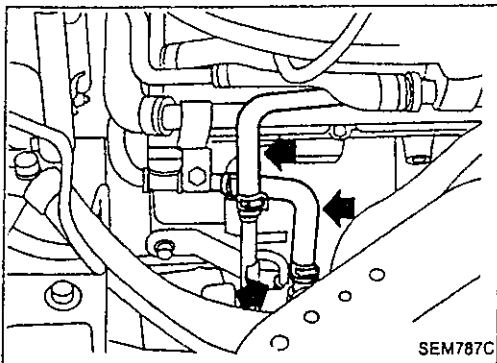

7. Remove turbocharger water hoses, and disconnect turbocharger oil inlet tube.
8. Remove two bolts fastening warm up three-way catalyst to turbocharger unit.

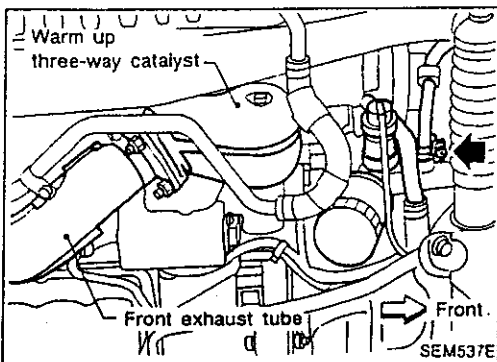

9. Remove the following parts;
 - oil pressure switch
 - oil filter
 - turbocharger oil return tube
 - front exhaust tube
 - warm up three-way catalyst
10. Disconnect oil hose from oil filter bracket, and turbocharger water tubes from turbocharger unit.

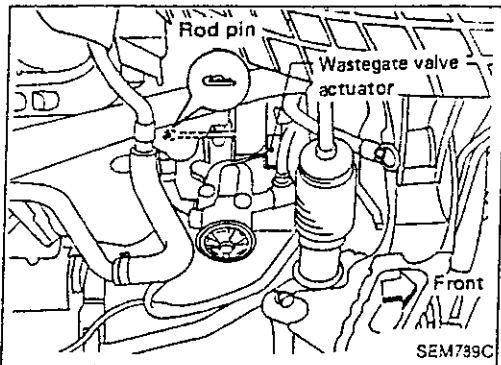

11. Remove rod pin of wastegate valve actuator.
12. Remove oil filter bracket.

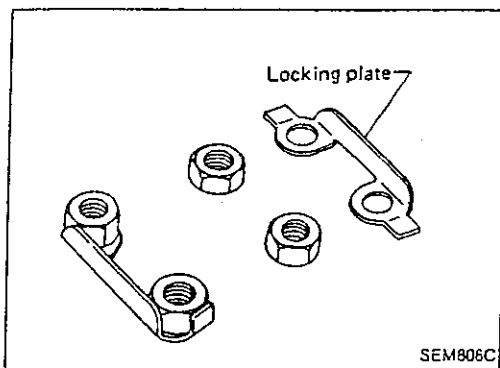

13. Unbend locking plates for fastening nuts of turbocharger unit.
14. Remove turbocharger unit.

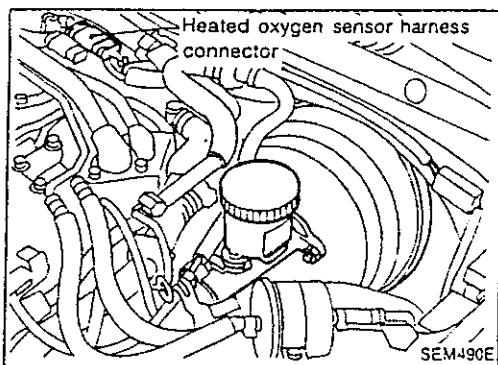

LEFT SIDE UNIT

1. Remove brake master cylinder and brake booster.
2. Disconnect heated oxygen sensor harness connector.

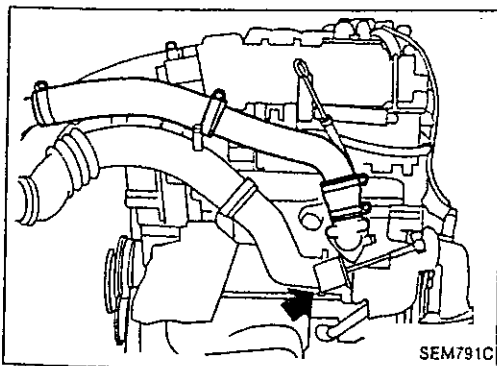

3. Remove air inlet hose and pipe.
4. Disconnect lower pipe from turbocharger unit.

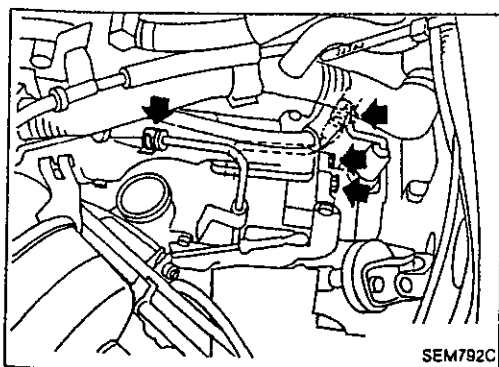

5. Disconnect water tubes.
6. Remove two bolts fastening warm up three-way catalyst to turbocharger unit.

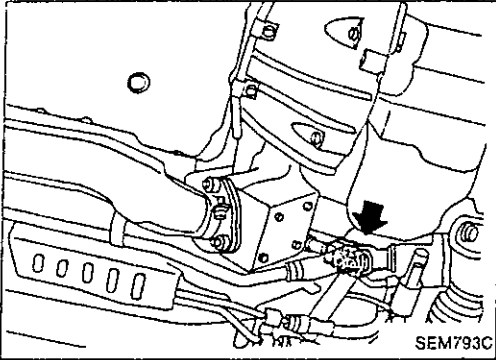

7. Remove front exhaust tube and warm up three-way catalyst.
8. Disconnect steering lower joint.

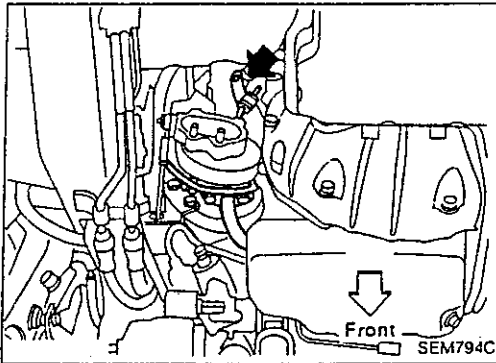

9. Remove turbocharger oil return tube and water tubes.
10. Disconnect EGR tube and actuator bracket of turbocharger wastegate valve.

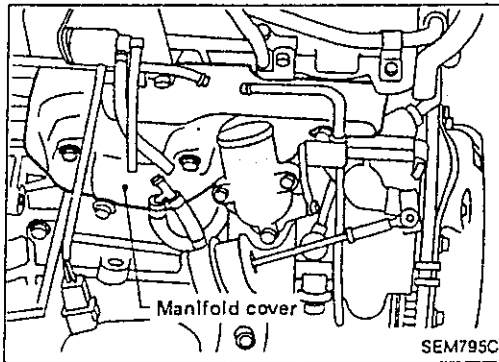

11. Remove manifold cover and fastening nuts.
12. Remove turbocharger unit with exhaust manifold.

3. GReddy Turbo Kit Installation

3-1 Left side (driver's side)

(1) Plug the factory water lines that went from the in and out of the factory turbocharger.

Use: #33

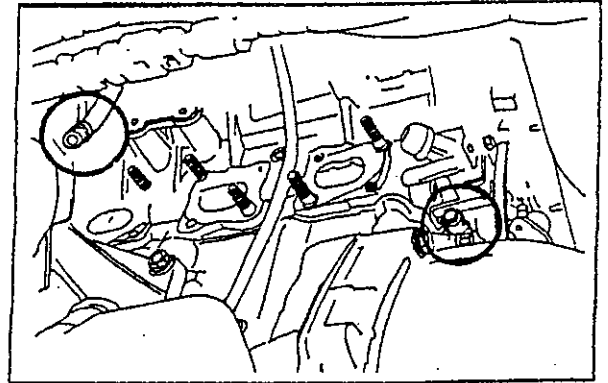

(2) Install the provided stud bolts onto the turbine inlet flange on the left exhaust manifold. Then install the exhaust manifold with the provided gasket onto the cylinder head.

Use: #4,36,56,57

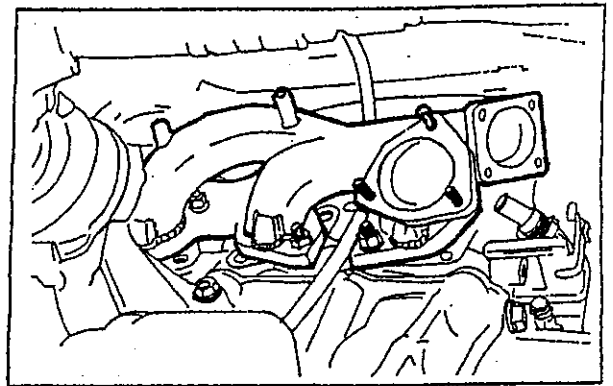

(3) Cut off the shaded area on the factory heat shield (as shown). Then install the modified heat shield onto the exhaust manifold using factory hardware.

Use: #factory parts

Note: It is very important that the factory heat shield is used.

Important! Always use safety glasses when cutting.

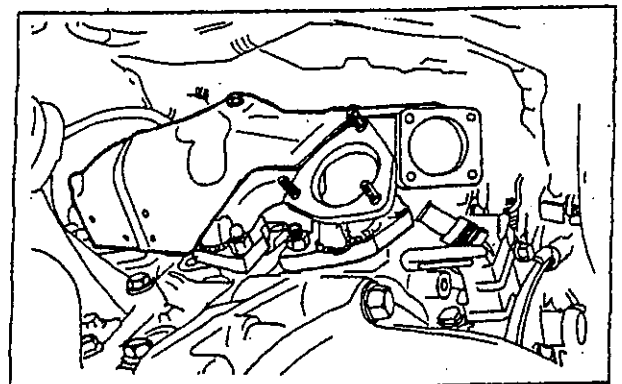
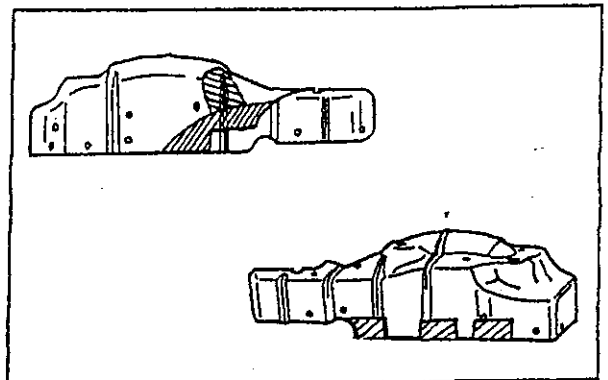

(4) Install the oil pressure line to the turbocharger using the banjo fittings. Next install the turbocharger to the exhaust manifold using the proper gaskets.

Use: #1,22,26,38,57

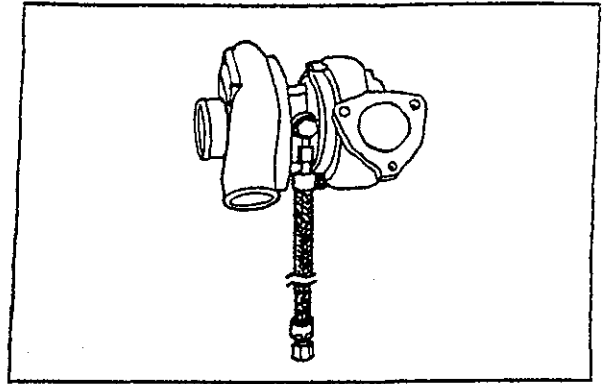

(5) Remove the left engine (trans) bracket, that secures the transmission to the engine.

(a) Then connect the turbo oil pressure line from the turbocharger to the factory oil pressure line.

Use: #30

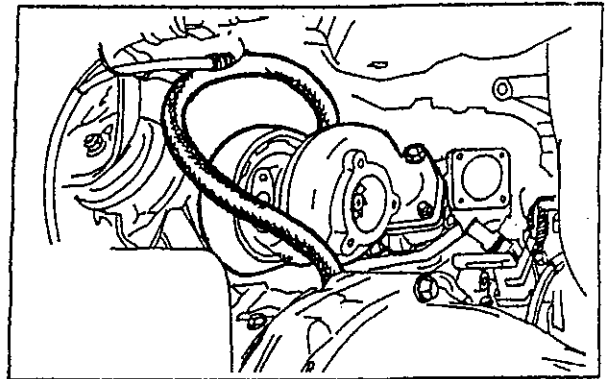

(b) Cut off the shaded area off the left engine trans. bracket. (as shown)

Important! Always use safety glasses when cutting.

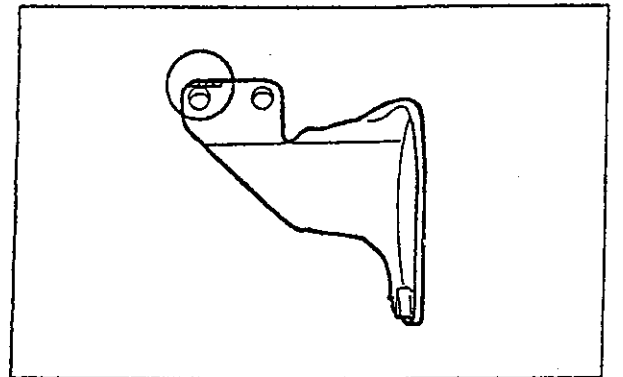

(c) Tie wrap the oil pressure line, so that it will be away from the turbocharger and the exhaust manifold.

Use: #30,54

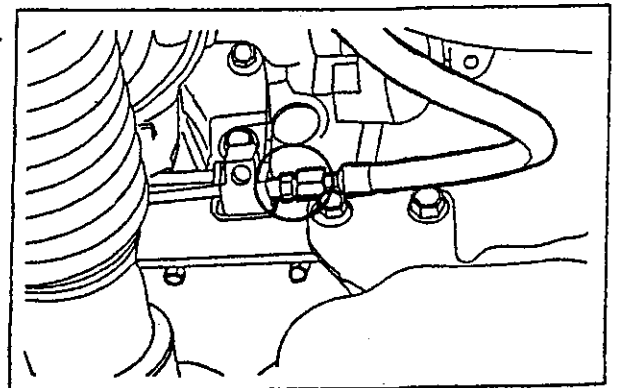

(6) Install the oil pressure pipe(L) to the turbocharger with the gasket.

Then wrap the 19Ø rubber hose with thermo cloth and install it between the the oil pressure pipe (L) and the turbo oil drain on the oil pan. Be sure to secure the hose bands tightly and the drain hose doe not have and kinks in it.

Use: #25,37,44,49,55,59

(7) Install the air pressure line to the wastegate use the provided fittings as shown.

Use: #2,23,28,29,31

Note: The other end of the air pressure lines will be connected later.

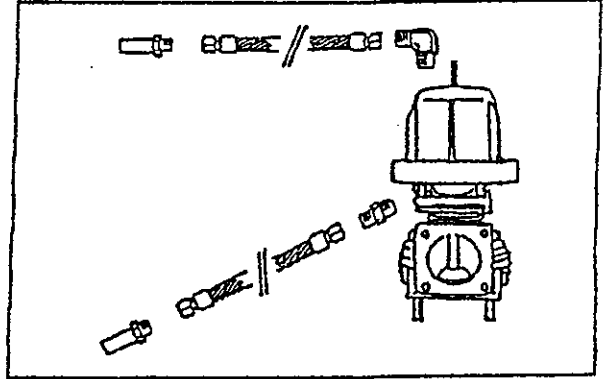

(8) Install the wastegate to the manifold using the wastegate gate adapter (L) as shown.

Use: #2,6,40,58

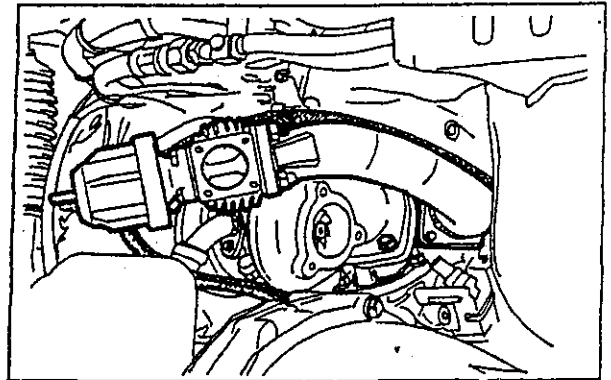

(9) Install the stud bolts to the turbine housing. Then install the O² sensor to the muffler adapter(L) Next install ht muffler adapter assembly and down pipe onto the turbine outlet. Also install the wastegate dump pipe (L) onto the wastegate outlet

Reconnect the steering lower joint.

Use: #8,10,39,41,55,56,57

Important! Wrap the O² wire with some thermo cloth.

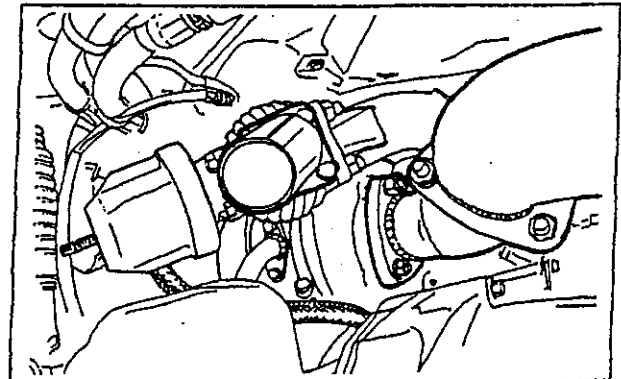

Piping Diagram (for left side)

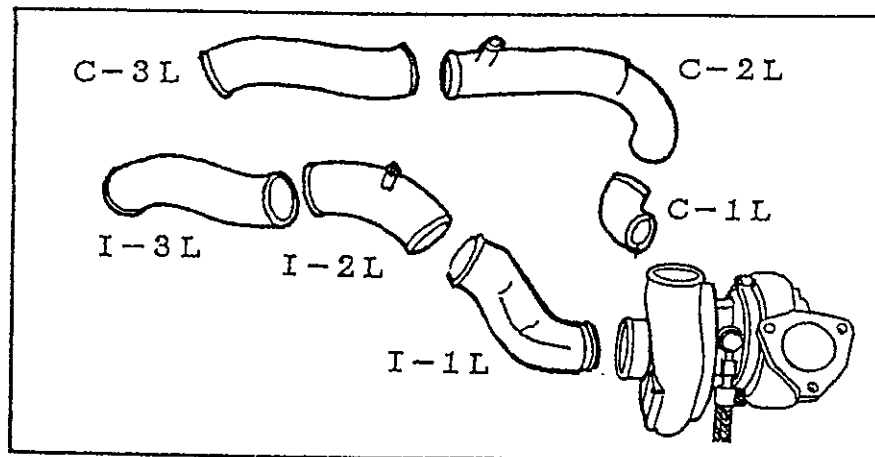

(10) Install suction pipes (I-1L, I-2L, & I-3L) using the provided hoses and hose bands according to the above diagram. Also reinstall the factory blow-by hose using factory hose band to I-2L pipe.
Use: #14,15,16,46,47,48,51,52,53,55

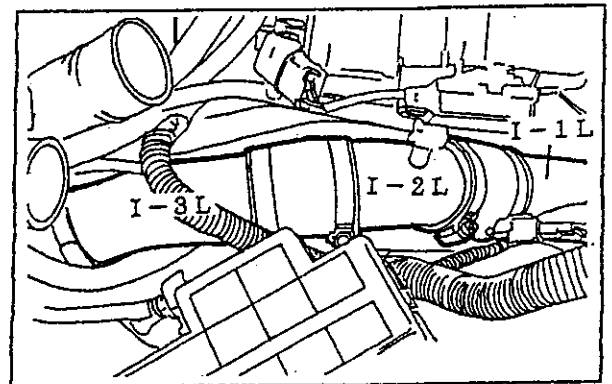

(11) Install the compression pipes (C-1L, C-2L, C-3L) using the provided hoses and hose bands. Also reinstall the factory air control hose to C-2L pipe using the factory hose bands.
Use: #19,20,21,45,46,50,51,55

Important! Wrap the hose that connects C-1L to the turbo compressor outlet with thermo cloth.

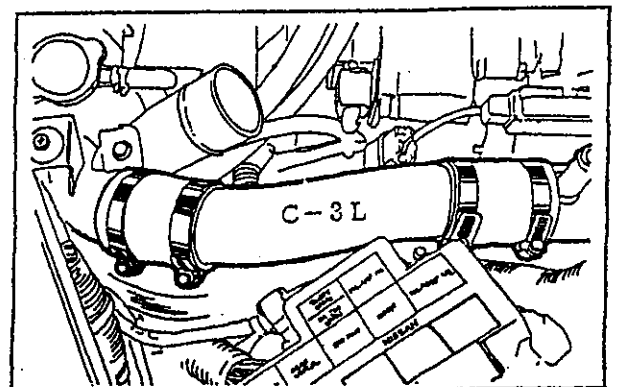
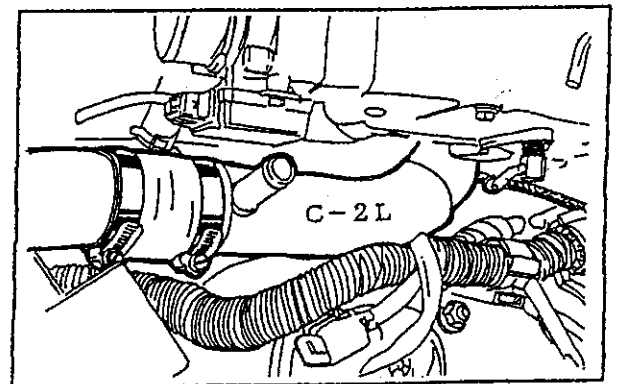

(12) Reinstall the factory charge pipes from the intercooler to the throttle body. Then reinstall every thing else that was connected on the left side.

3-2 Right Side (passenger side)

(1) Plug the factory water lines that went from the in and out of the factory turbocharger. (use factory clamps)
Use: #33,54

Note: It is very important that the factory heat shield is used.

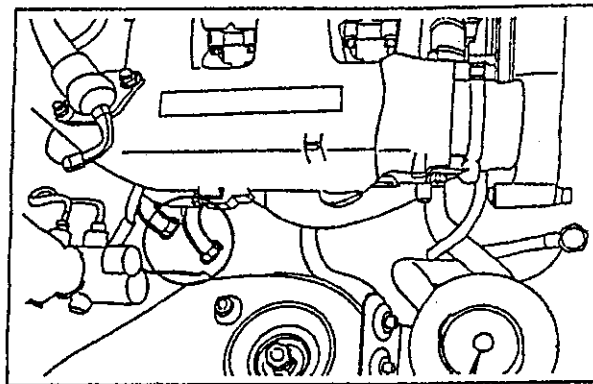

(2) Install the provided stud bolts onto the turbine inlet flange on the left exhaust manifold. Then install the exhaust manifold with the provided gasket onto the cylinder head.
Use: #3,36,56,57

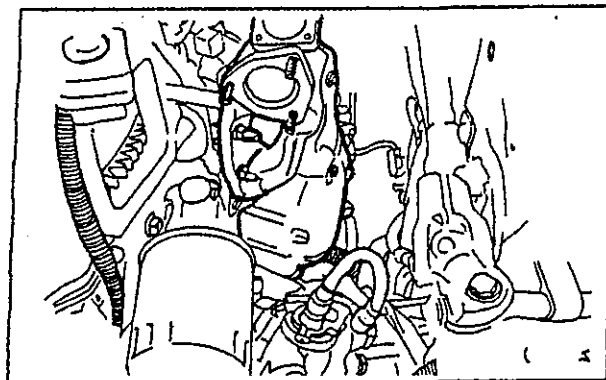

(3) Install the factory exhaust manifold that was modified in step 3-1 (3).
Use the factory hardware.

(4) Install the provided fitting onto the engine block as shown.
This fitting is for the oil pressure line.
Use: #29

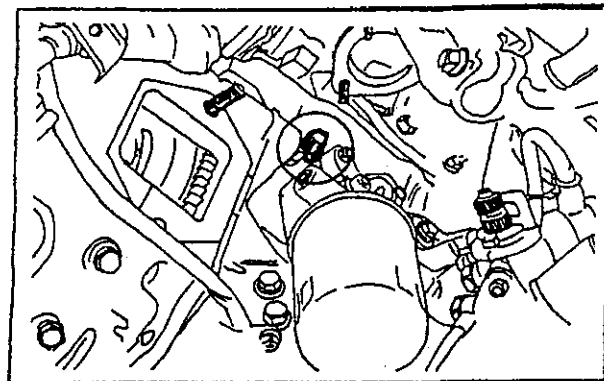

(5) Remove the factory fitting (for the oil cooler) located on the on the oil filter bracket. Next replace this fitting with the provided banjo fitting.

Use: #27, 42

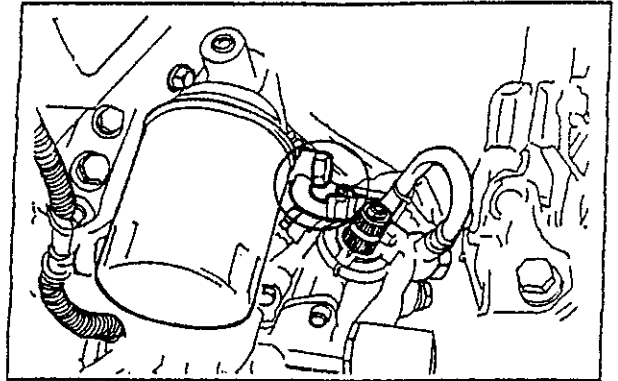

(6) Install the oil pressure line to the turbocharger using the banjo fittings. Next install the turbocharger to the exhaust manifold using the proper gaskets.

Use: # 1,22,26,38,57

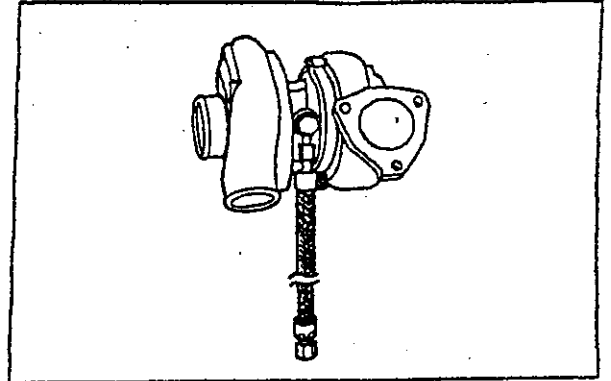

Install the oil pressure pipe(R) to the turbocharger with the gasket.

Then wrap the 19Ø rubber hose with thermo cloth and install it between the the oil pressure pipe (R) and the turbo oil drain on the oil pan. Be sure to secure the hose bands tightly and the drain hose doe not have and kinks in it.

Use: #24,44,49,55

Connect the oil pressure line to the fitting that was installed to the block in step 3-2 (4)

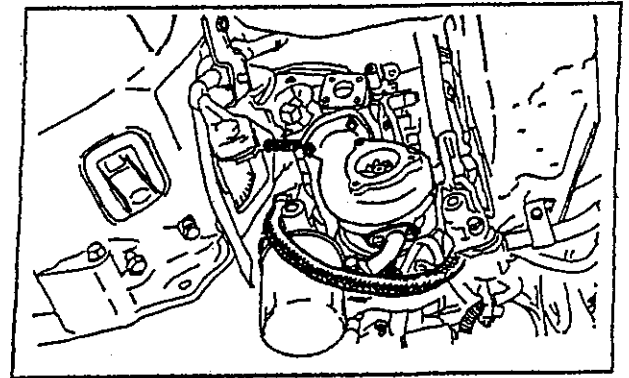

(7) Install the air pressure line to the wastegate use the provided fittings as shown.

Use: #2,23,28,29,31

Note: The other end of the air pressure lines will be connected later.

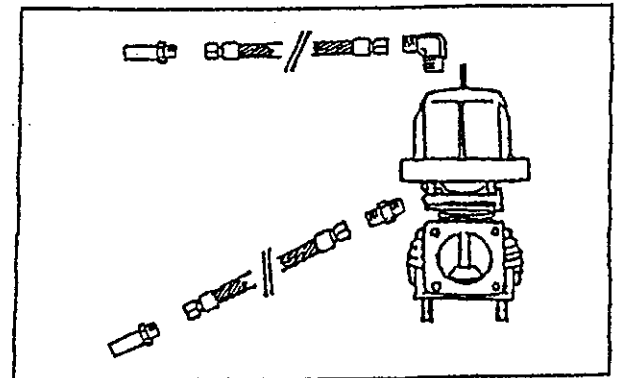

(8) Install the wastegate to the manifold using the wastegate gate adapter (R) as shown.
Use: #2,5,9,40,58

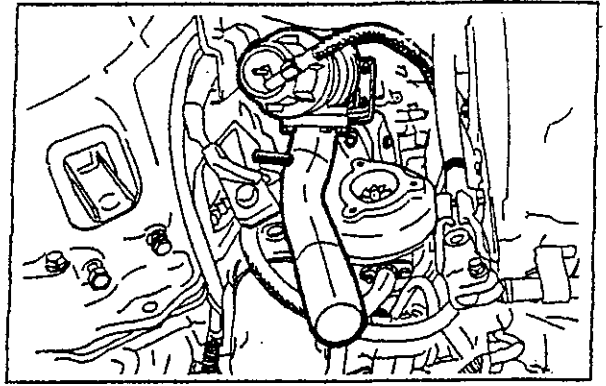

(9) Install the stud bolts to the turbine housing. Then install the O² sensor to the muffler adapter (R). Next install the hot muffler adapter assembly and down pipe onto the turbine outlet. Also install the wastegate dump pipe (R) onto the wastegate outlet. Reconnect the steering lower joint.
Use: #7,39,54,57

Important! Wrap the O² wire with some thermo cloth.

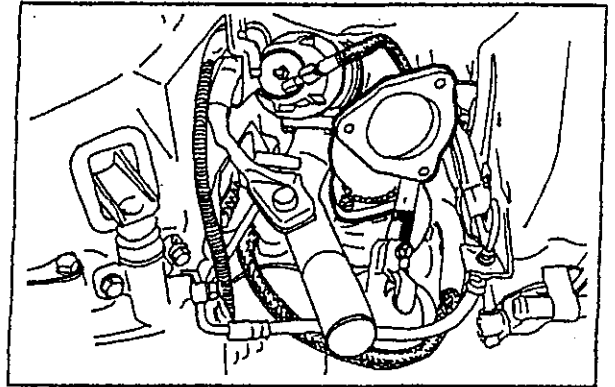

(10) If the starter or clutch release cylinder was removed, reinstall at this time. Then install the down pipe onto the muffler adapter using the provided stud bolts and gaskets.

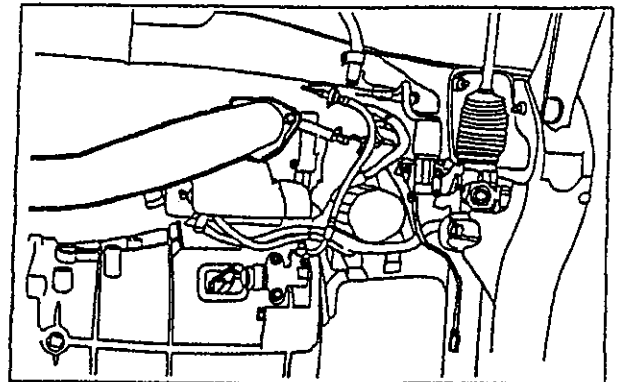
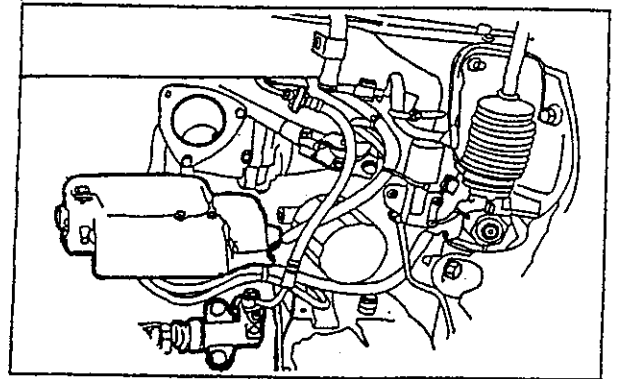

Piping Diagram (for left side)

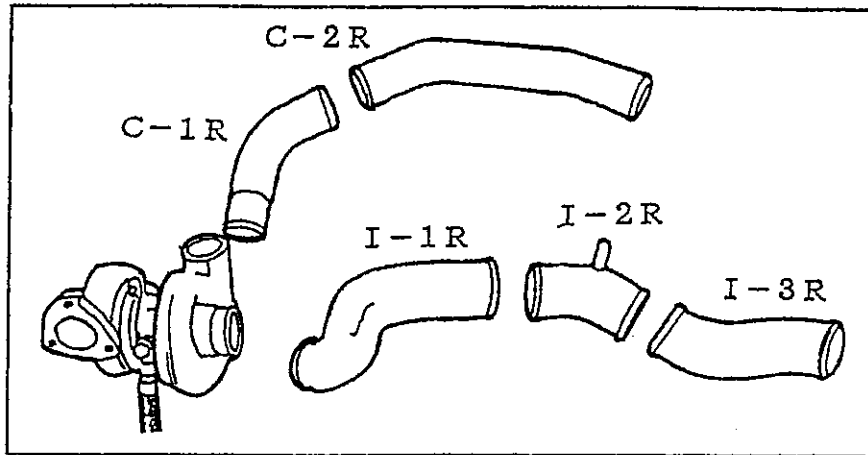

(11) Install suction pipes (I-1R, I-2R, & I-3R) using the provided hoses and hose bands according to the above diagram. Also reinstall the factory blow-by hose using factory hose band to I-2R pipe.
Use: #11,12,13,46,47,48,51,52,53,55

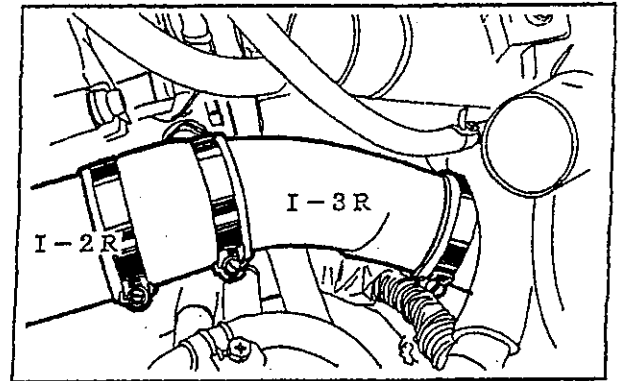

(12) Install the compression pipes (C-1R, C-2R, C-3R) using the provided hoses and hose bands.
Use: #17,18,45,46,50,51,55

Important! Wrap the hose that connects C-1L to the turbo compressor outlet with thermo cloth.

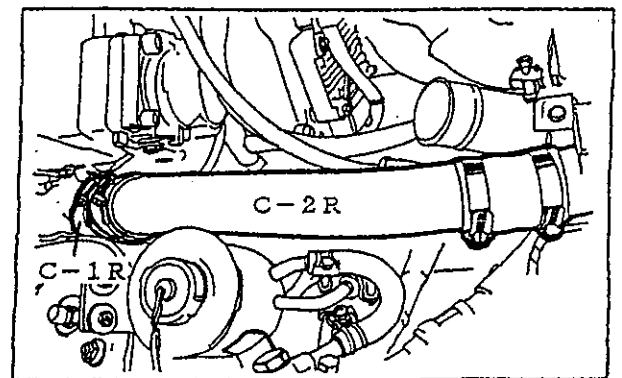

(13) Reinstall the factory charge pipes from the intercooler to the throttle body and reconnect everything that was disconnected on the right side.

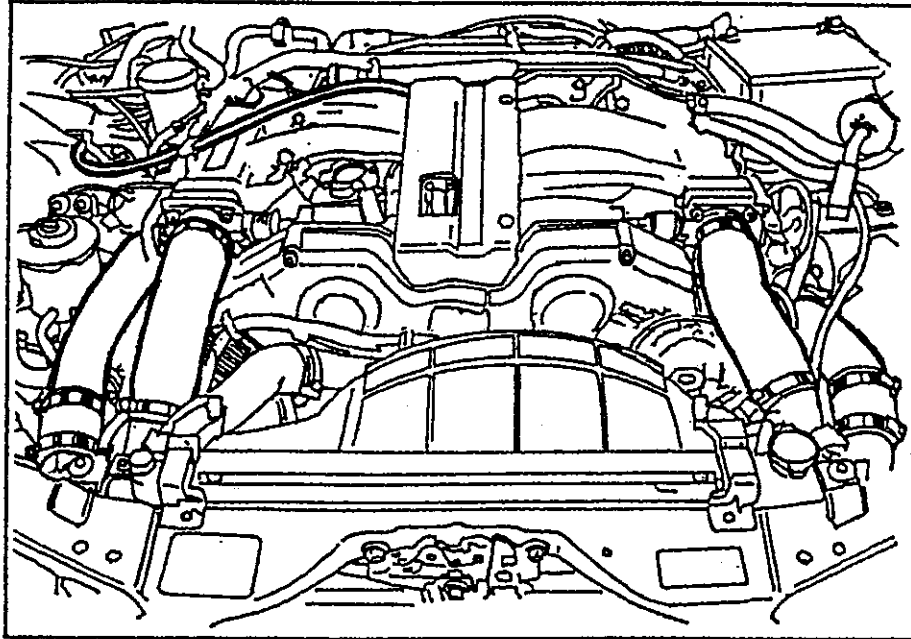

3-3 Wastegate Air Line Routing

(1) With out a boost controller.

Connect the air pressure line that is connected to lower port on the side of the wastegate to the intake manifold (pressure/vacuum)

(2) Remove the air pressure line connected to the top port of the wastegate and leave the port open to atmosphere

(3) With a boost controller.

Leave the air pressure line at the top of the wastegate connected and refer to the boost controllers instruction manual for proper installation.

Use: #34,35,43,54

3-4 EGR

- (1) Plug the EGR vacuum hose with the provided plug and caps
Use: #32
(The EGR will no longer be operable)

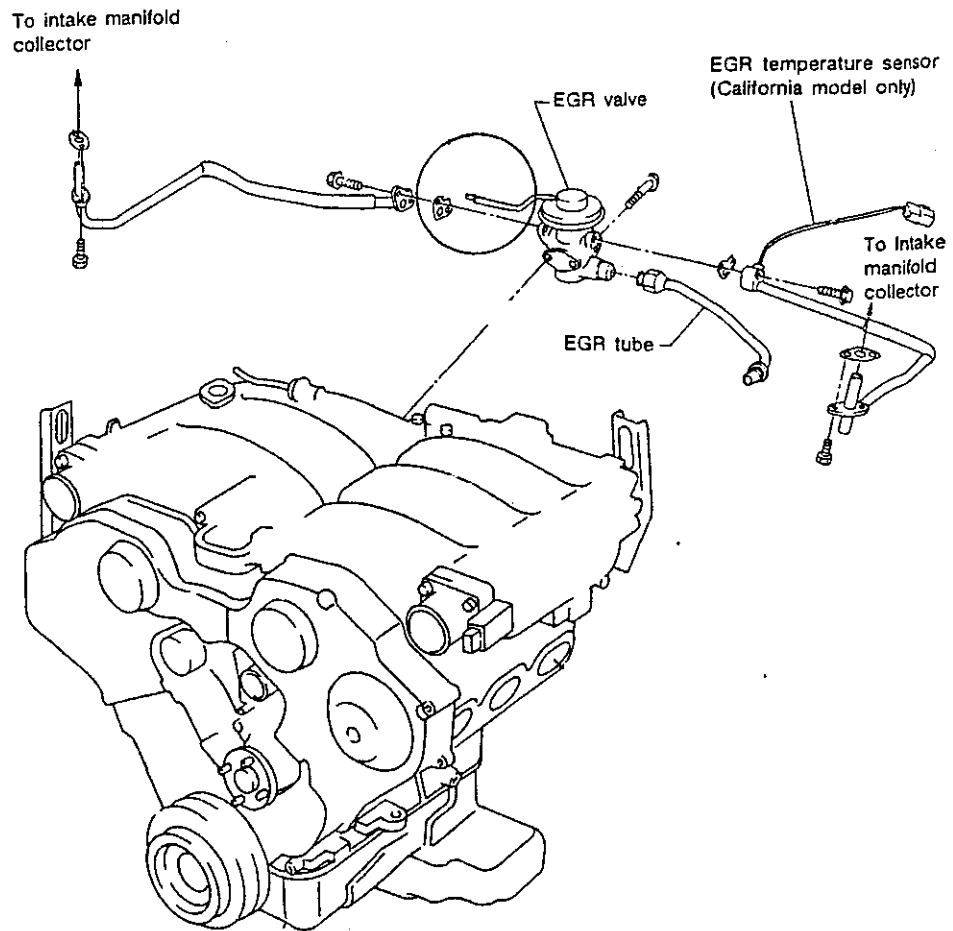

3-5 Checking for Leaks.

- (1) Refill coolant levels
- (2) Reconnect the negative terminal of the battery
- (3) Crank the engine, without starting it to build proper oil pressure before starting the engine.
- (4) Start the engine and check for oil, water, and air leaks.
- (5) Check the if the steering system is working properly.

This completes the installation.